

INSTALLATION MANUAL

SEQUENTIAL INJECTION SYSTEMS

- OBD SELF-ADAPTIVE SYSTEM**
- PARALLEL PETROL INJECTION**
- COMPACT 4 CYL. SYSTEM**

Installation Manual

Revision 05, October 2013

1. GENERAL RECOMMENDATIONS	- PAGE 4
2. INSTALLATION DIAGRAM	- PAGE 5
3. OPERATION OF THE SWITCH	- PAGE 8
4. INTERFACE SOFTWARE	- PAGE 9
5. INTRODUCTION	- PAGE 9
6. MENU "SETTINGS"	- PAGE 9
7. PRESETTINGS OF THE SYSTEM	- PAGE 11
8. MENU "SWITCHOVER"	- PAGE 12
9. MENU "AUTOTUNING"	- PAGE 13
10. MENU "MANUAL TUNING"	- PAGE 14
11. MENU "FINE TUNING"	- PAGE 15
12. SELF-ADAPTIVITY MENU	- PAGE 16
13. MENU "DIAGNOSTICS"	- PAGE 17
14. MENU "DATA BASE"	- PAGE 18
15. MENU "MAP"	- PAGE 19
16. MENUS "ADVANCED SETTINGS"	- PAGE 20
17. MENU "CORRECTIONS"	- PAGE 23
18. OBD/ CAN COMMUNICATION MODUL	- PAGE 24
19. MENU "GAS SYSTEM ERRORS"	- PAGE 25
20. SOME USEFUL HINTS	- PAGE 26
21. SOME DETAILS ABOUT PROBLEM CARS	- PAGE 27

B4 OBD Sequential injection is a new generation controller equipped with system that constantly monitors short and long term STFT, LTFT corrections and oxygen sensor B4 OBD easily communicates with all OBD II and OBD auto systems (not only CAN) by OBD ADAPTER which aside from standard parameters enables the read out of your vehicle's ECU corrections.

The technology applied in B4 OBD system assures the very precise fuel dosage and optimal fuel mixture injected into the cylinders. The contents of the mixture is configured not only based on the petrol injection timing as it is in other controllers, but it is precisely adopted to current petrol ECU corrections while driving on gas (not only during the calibration).

B4 OBD was created with accordance to plug and drive, user friendly technology, which makes it very simple to install and use. After the first calibration during the installation, B4 OBD self-adopts in real time during standard vehicle usage. Moreover when installation of the system is made properly, B4 OBD system can be run even without calibration.

This guaranties the same precise efficiency and proficiency on LPG/CNG as it is on Petrol.

Only B4 OBD can guarantee the fullest, flawless integration with the vehicle's factory settings.

B4 OBD is designed for all vehicles with 3 to 8 cylinder petrol engines.

Vehicles equipped with B4 OBD fulfill the EURO 5 emission norms.

Advantages of B4 OBD:

- Permanent, non interference connection with vehicles OBD, allowing connections of testers, diagnostic tools etc.
- Minimizes the risk of defects associated with imprecise manual calibration.
- Keeps the key engine settings such as power, torque identical to the petrol settings.
- Fulfills the EURO 5 emission norms
- Optimizes the fuel consumption also in high RPM and high engine loads, and prevents the engine ECU from check engine mistakes like misfire, too rich or too lean mixture.

1.0 GENERAL RECOMMENDATIONS

- Before installing the gas system, disconnect the battery earth cable (unless specified to the contrary by the car maker).

Attention: this may delete the car radio and telephone memories and jam the centralised door locking and anti-theft systems. In this case, you may connect the battery temporarily.

- Always smooth holes after drilling and apply anti-rust to the edges.
- Apply silicon to each cable through-hole to prevent water from entering the interior.
- Install the control unit as far away as possible from areas where water could infiltrate, far away from heat sources (e.g.: exhaust manifolds), far away from high-voltage cables and, wherever possible, with the connector pointing downwards.
- If the fuse blows, do not replace it with one of a higher current rating.
- Do not attempt to open the control unit as this could cause irreparable damage. B4 OBD declines all liability for injury to people or damage to property should its equipment be tampered with. In this event the warranty shall also be invalidated.
- Always make electrical connections using the relative joints or soft solder them to prevent the formation of false contacts.
- Always observe the current laws and/or regulations in the State where the LPG system is mounted.
- Remember that, as per the relative standards, all the assembly instructions refer to the driving position.
- Before mounting the electronic control unit, make sure the relative fuses are disconnected.
- Do not wash the engine after installation.

WARNING

FAILURE TO OBSERVE THE INSTRUCTIONS CONTAINED IN THIS MANUAL MAY CAUSE THE SYSTEM TO WORK INCORRECTLY OR NOT WORK AT ALL. THIS MAY CAUSE DAMAGE TO B4 OBD COMPONENTS AND INVALIDATE THE WARRANTY.

1.1. CONNECTION OF THE INJECTORS CUT-OFF WIRING.

Verify the polarity of the injectors acting as follows:

1. Disconnect all connectors of the original injectors.
2. Prepare a multimeter to measure the direct voltage with full range equal to 20V and connect the negative lead to the ground.
3. Place the positive lead on one of the contacts of the connector injector.
4. Insert the panel and check on the multimeter the measured voltage value. If the reading is about 12V, that is the positive cable.

WARNING

FEEDING OF THE INJECTORS IS TIMED; THEREFORE, AFTER SOME SECONDS FROM SWITCHING ON OF THE PANEL, IT IS DISABLED. IT IS SUGGESTED TO VERIFY THE POLARITY OF ALL INJECTORS, SINCE SOME CARS HAVE AN INVERTED INJECTOR WITH REFERENCE TO THE OTHERS.

After having verified the polarity of the injectors, it is possible to connect the injector emulation harness.

Cut the petrol injector negative wire. The one of the wires have to be connected to the injectors; while the other have to be connected to the gasoline injection control unit. Respect the matching between the sheath of the injector emulator wiring and the gas injector.

In case of connection on a 3-cylinder car, the YELLOW wires have to be left disconnected.

2. INSTALLATION DIAGRAMS

Installation diagram B4 OBD SEQUENTIAL LPG/CNG SYSTEM 3, 4, 5, 6, AND 8 CYLINDERS

LPG/ petrol turn-over switch,
level meter and buzzer

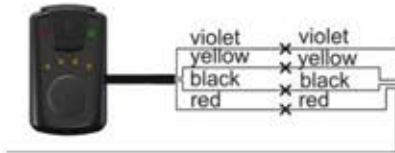

white-red +12V engine on
(to the fuel pump power supply)

NOTE!
CHOOSE THE LEVEL SENSOR TYPE
FROM THE SOFTWARE MENU!

**FOR LPG LEVEL SENSOR WITH
TWO WIRES AND CNG SENSOR ON 12V -
DO NOT CONNECT GREEN WIRE!**

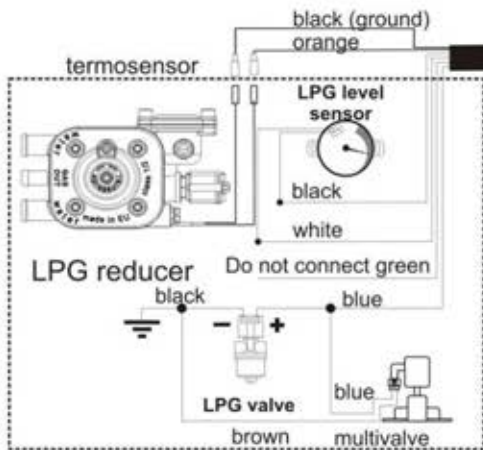
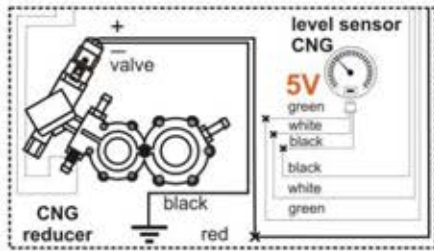

violet
(Lambda sonda)

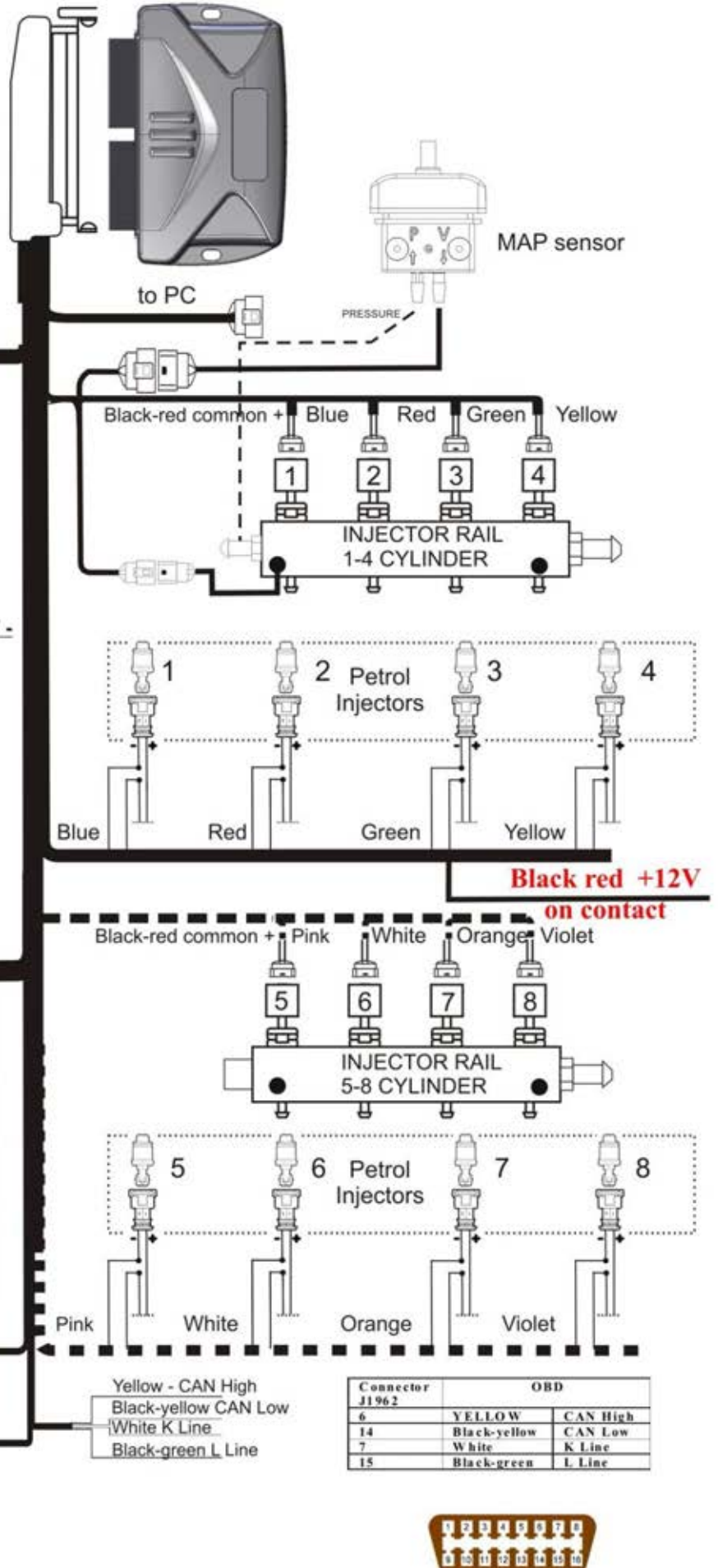
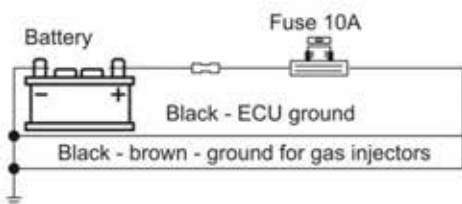

Connector J1962	OBD	
6	YELLOW	CAN High
14	Black-yellow	CAN Low
7	White	K Line
15	Black-green	L Line



ECU

Installation diagram LPG/CNG SYSTEM COMPACT 4 CYL.

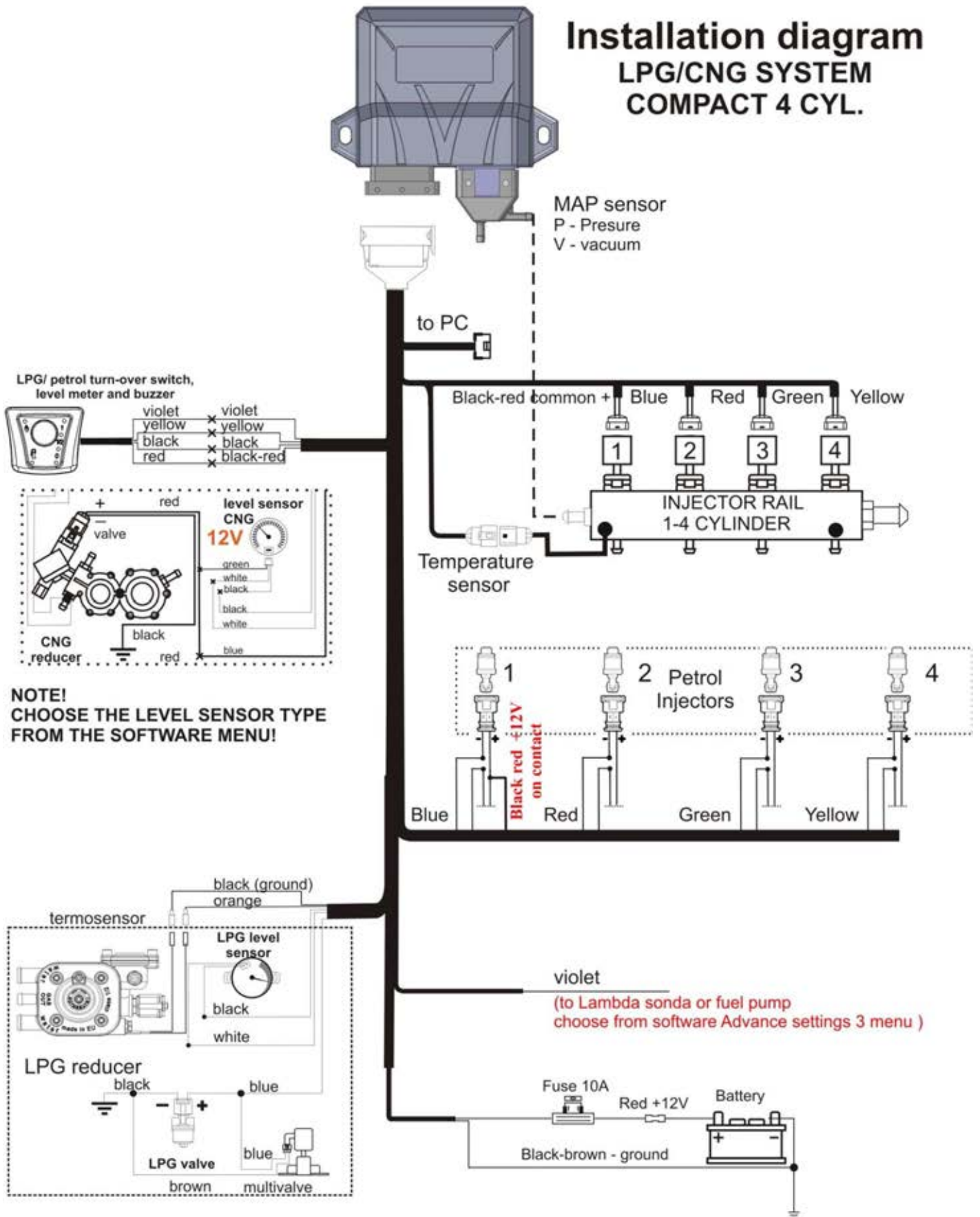

NOTE!
CHOOSE THE LEVEL SENSOR TYPE
FROM THE SOFTWARE MENU!

Installation diagram OBD SEQUENTIAL INJECTION LPG/CNG SYSTEM WITH PARALLEL PETROL INJECTION 4 CYLINDER

LPG/ petrol turn-over switch,
level meter and buzzer

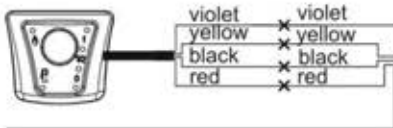

white-red +12V engine on
(to the fuel pump power supply)

NOTE!
CHOOSE THE LEVEL SENSOR TYPE
FROM THE SOFTWARE MENU!

**FOR LPG LEVEL SENSOR WITH
TWO WIRES AND CNG SENSOR ON 12V -
DO NOT CONNECT GREEN WIRE!**

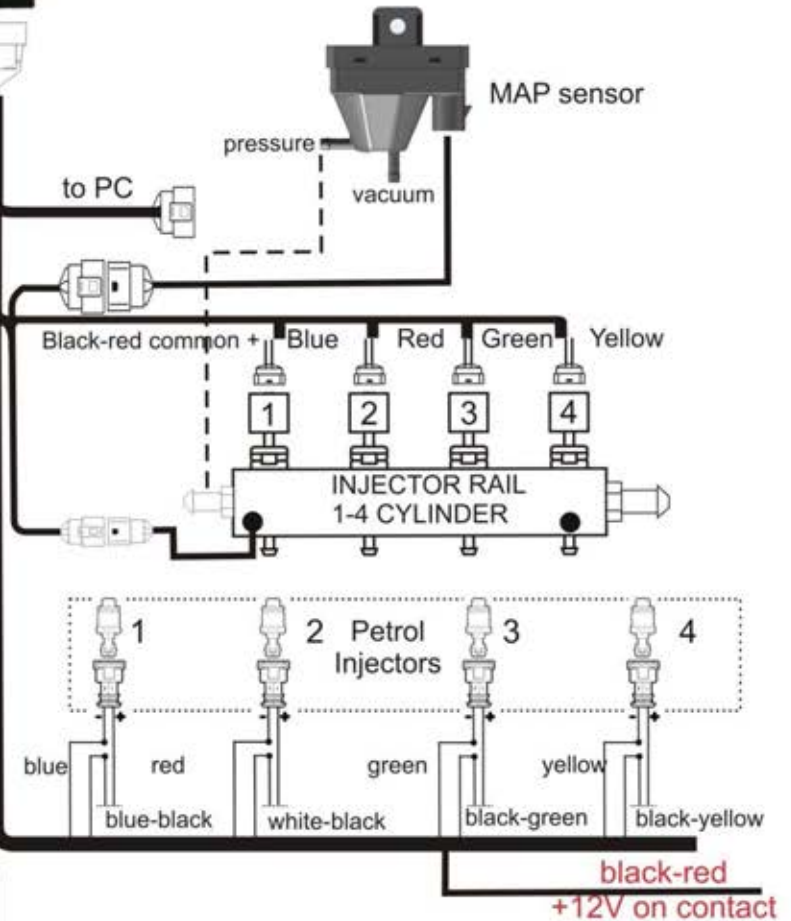
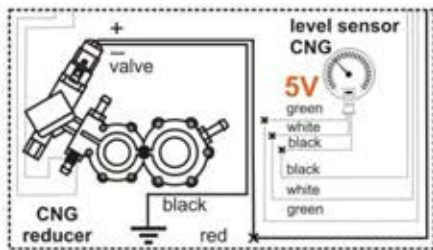

IMPORTANT!

**PETROL INJECTORS CUT OFF -
MAIN COLOR WIRES TO INJECTORS
DOUBLE COLOR WIRES TO PETROL ECU!!!**

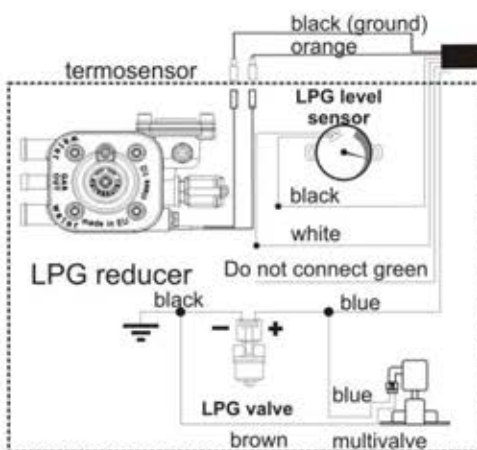

violet
(Lambda sonda)

Yellow - CAN High
Black-yellow CAN Low
White K Line
Black-green L Line

Connector J1962	NIGS OBD	
6	YELLOW	CAN High
14	Black-yellow	CAN Low
7	White	K Line
15	Black-green	L Line

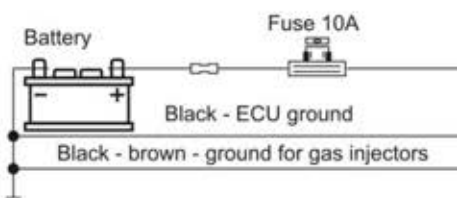

3. OPERATION OF THE SWITCH

The switch supplied with the kit is equipped with a push-button, LEDs, and an internal buzzer.

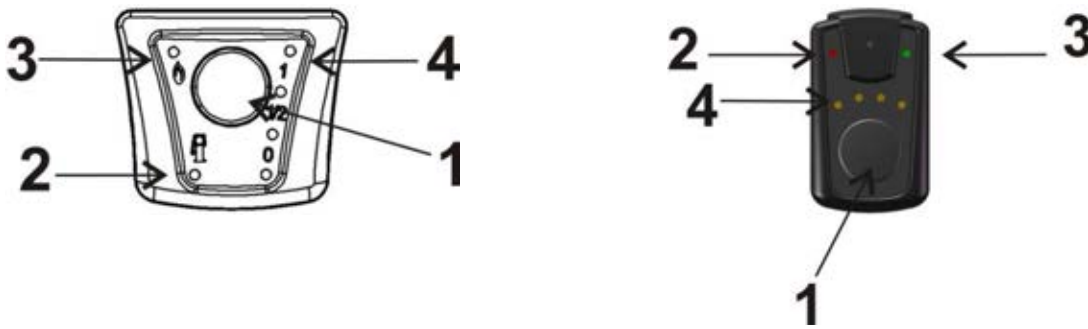

ITEM DESCRIPTION

1	PUSH BUTTON It is used to select the type of feeding (petrol or gas). By pressing it, it is possible to switch from one type of fuel to the other.
2	[RED LED ON] Car running on petrol
3	[GREEN LED ON] Car running on gas
4	[YELLOW LEDs] Quantity of gas in the tank

SWITCHING TO PETROL DUE TO GAS LOW PRESSURE

When the switch reaches the reserve and the gas pressure falls under a pre-set value, the control unit switches automatically to the petrol feeding. This occurs to avoid that the engine can operate with a too weak mixture damaging in this way the catalytic converter. Before switching again to the gas feeding, perform a fuel filling. The switching to petrol due to GAS LOW PRESSURE is signaled by the switch with the switching-on of the RED LED (petrol operation), and switching off the GREEN LED indicator and of the YELLOW LEDs and by the acoustic warning given by the internal buzzer. To stop the buzzer buzzing it is necessary to press the PUSH-BUTTON once; the RED led stays ON. After fuel filling the system will start on gas mode automatically.

EMERGENCY

If the car is not able to start with petrol (e.g. due to problems on the petrol pump, etc.), it is possible to start it directly on LPG. To do this, keep the switch push button pressed for 25 sec and than start the engine.

Delete the OBD errors - When the "CHECK" light is on at any error, through system with integrated OBD module, you can delete the errors.
In contact on key position and subsequent rapid pressing the GAS-PETROL switch four times, all errors registered to date are deleted.

WARNING

DIRECT GAS STARTING IS TO BE CONSIDERED AN EMERGENCY OPERATION. ITS REPEATED USE CAN LEAD TO DAMAGES TO THE CATALYTIC CONVERTER OR THE SWITCHING ON OF THE CHECK ENGINE WARNING LAMP.

4. INTERFACE SOFTWARE

MINIMUM REQUIREMENTS OF THE COMPUTER TO INSTALL THE SOFTWARE

- Operating system - Windows 98 2nd edition or following versions
- Memory (RAM) - At least 16 MB
- Hard disk - At least free 20 MB upon installation
- Screen resolution - 1024 x 768 or higher

1. Install file "dotnetfx.exe". If Windows OS is older version and you can't install the program, you have to install "WindowsInstaller.exe" after that try to install "dotnetfx.exe" again. Once installed, "dotnetfx.exe" run anytime, no need to be installed for new versions.

2. Install USB driver "PL-2303 Driver Installer.exe".

3. Copy the file "B4 .exe" into your computer and start it.

If the program doesn't connect with LPG ECU, please specify COM Port which is used for you, by button "COM/Language".

5. INTRODUCTION

The calibration software can be opened without being necessarily connected to the control unit. To connect to the control unit, it is instead necessary that the PC and the control unit are correctly connected by USB cable.

(Moreover, the control unit has to be connected to the +12 volt battery (RED wire), to the ground (BLACK wire) and to 12V under key (dashboard ON - engine OFF)

6. SET UP MENU

From this menu, it is possible to access main parameters in all sub-menus of the calibration software that are given and individually described here below.

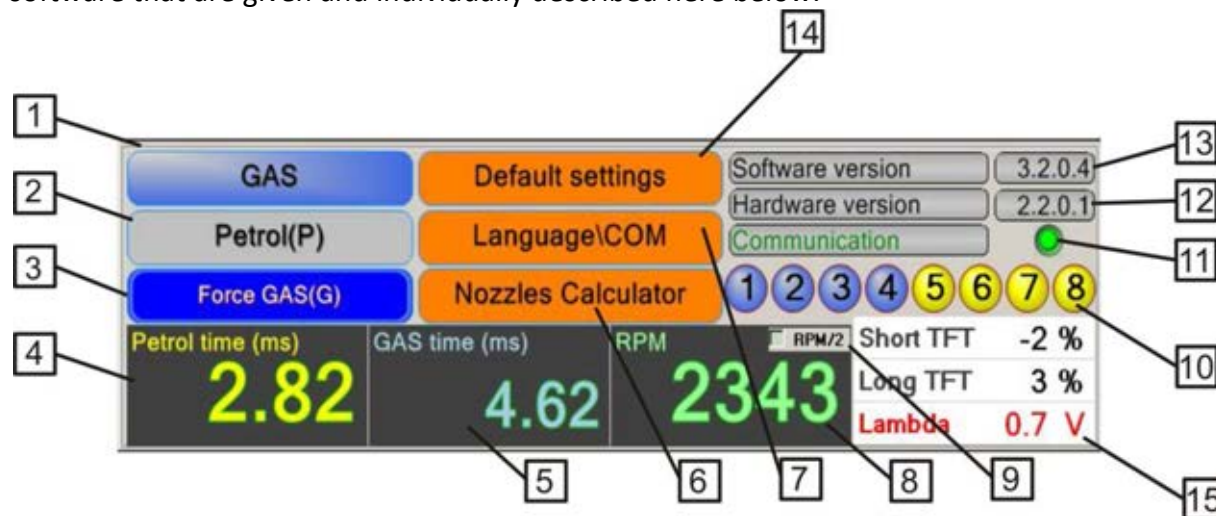

FIG.1

1 - Button LPG – it working when reducer temperature is reached /Blue active , Gray not active/
2 - Button Petrol – active when it is in yellow color and not active when it is grey color
3 - Force GAS – you can switch immediately to LPG no matter of the temperature and sequence of the cylinders
4 - Petrol injection time in milliseconds (ms)
5 - LPG injection time in milliseconds (ms)
6 - Nozzles calculator
7 - Button for language and “COM Port” setting
8 – RPM meter
9 – RPM separator for full group and semi- sequent engines /if it is needed/
10 - Switch over separately the cylinders from GAS to Petrol and from Petrol to GAS (yellow - Petrol, blue - GAS)

11 - Communication between ECU and PC. Green light active, red light – no communication
12 – Hardware version information
13 - Software version information
14 – Default settings button
15 – Short TFT/Long TFT – seen only with OBD system

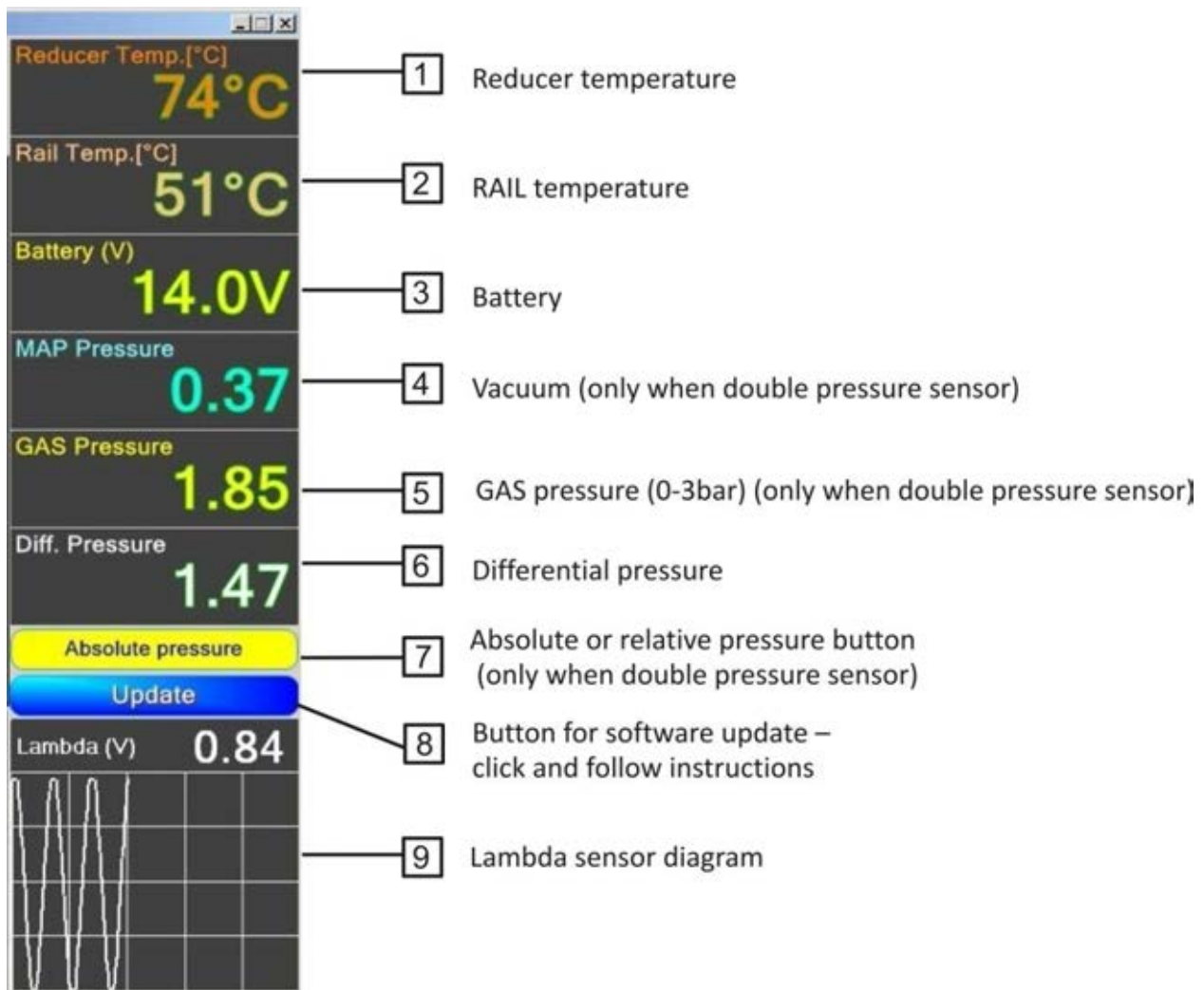

FIG.2



Nozzle calculator – here you can calculate proper size of the nozzles, according to engine power, pressure of the reducer and type of injection.

7.0 Presettings of the system – SET UP (F1) – FIG.3

It is necessary to select from the first **menu “SET UP”** number of the cylinders, approximately power in h.p., fuel type, the type of temperature sensor of the reducer, injector rail type, sensor delay time etc. Level sensor - from this menu you can choose type of sensor and also adjust all 4 levels by sliders. Moving non standard type sensor you could adjust all 4 levels, measured in volts. On the screen are shown the LED-s from the switch - petrol, gas, reserve, 1/4, 1/2, 3/4. When the level from multivalve is increasing and the voltage from the sensor is decreasing, you have to choose “Non standard reverse sensor”. The adjustment procedure is the same.

When you choose fast injectors like Horizon, keep in mind to use one or two sizes smaller nozzles due to bigger flow at idle, the curve of the coefficients Will be in this case at the beginning close to 1, at the end have to be 1.4-2, depend of the power of the engine.

FIG.3 /only if using COMPACT system, choose purple wire usage/

8. Menu “SWITCHOVER” (F2) (FIG.4)

After completing the initial settings you can select menu “SWITCHOVER” in order to set proper temperatures, pressures, times and switch over RPM.

Slider – “Switchover time cylinders” - with this slider you can choose slower or faster switchover from petrol to gas (expect the case when is choosen check box “Simultaneously switchover from petrol to gas” – upper right part of the screen).

Slider – “Switchover temperature from gas to petrol” – when there are problems in cooling system or freezing of the reducer you can choose switchover temperature below it the system automatically turn over to petrol and vs.

Switchover RPM Petrol to Gas slider - you could choose the RPM when the cold engine starts on gas, it is for the problem cars only for first switch-over. Basically this function is switched off.

Sometimes in cold weather (under 10°C) the injectors need to be moved primary to be ready to work properly till became warmer, so there is procedure for regulation – the time in sec. for switching each cylinder on gas. This could be made by slider Switch over time cylinders. In the same time for first turn over from petrol to gas it is provided possibility for adjustment of the RPM when is done.

FIG.4

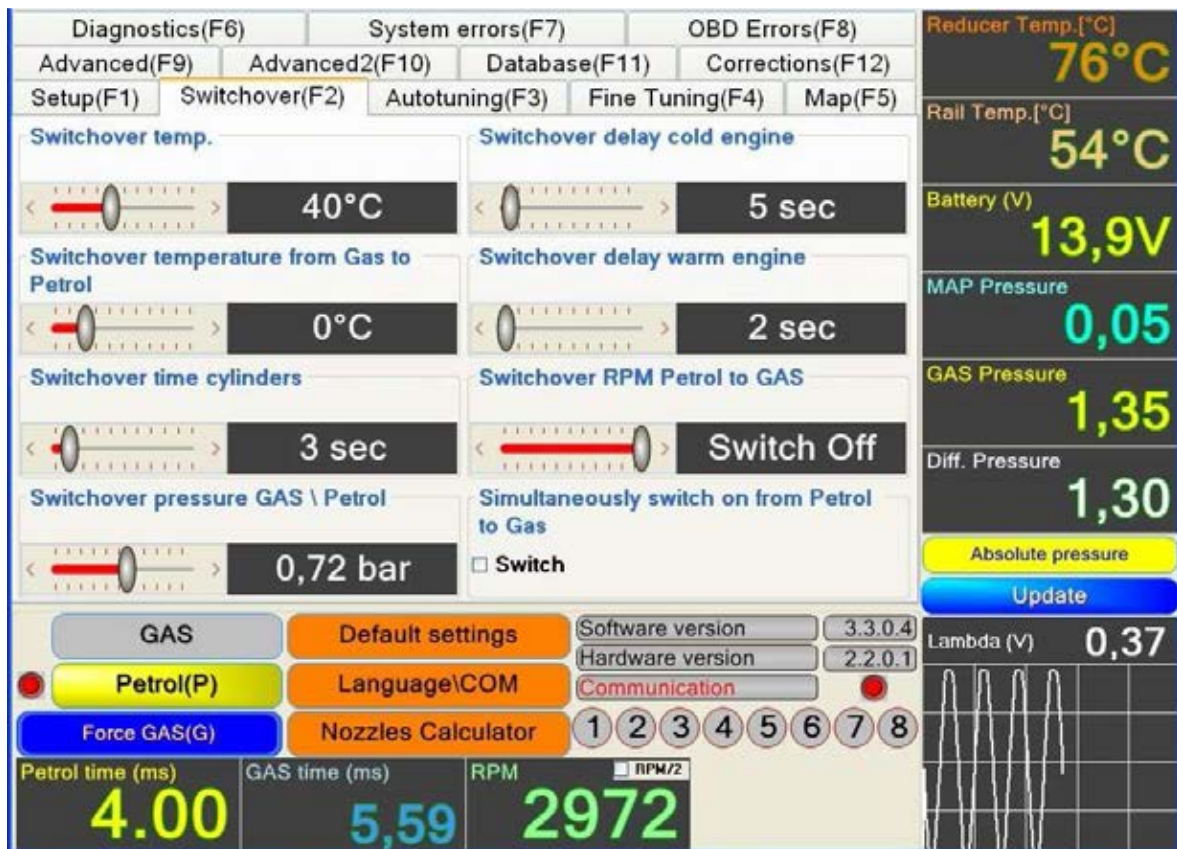

9. Menu “Autotuning” (F3) FIG.5

If the engine is working well you can go to “Autotuning mode” (FIG.5). It has to be done when all the power consumers are switched off (A/C, window, seat and mirror heaters, lights, cooling fan of the radiator). The engine must reach minimum 60°C and you have to sure by the lambda sensor data that the petrol ECU regulates. Than the AUTOTUNING procedure can start by pressing the button. Follow the instructions in a few steps that will appear in red colour in the field.

Step 1 - Calibration at idle mode.

Step 2 - Force engine several times (5-6) to get maximum petrol times.

Step 3 - reach 3000 +/- 500 RPM without load and keep it permanent, you can push the “next step” button.

After 20-50 seconds in the dark field you’ll see the number between 1-2.5 and message “OK” under it, which means the auto tuning is finished. There is a possibility to choose 3 different ways of driving depending on the driver’s preferences, conditionally called “Economic”, “Normal”, “Sport”. They could be chosen by using the checkboxes in screen. In case the “Auto tuning” mode is not working, you’ll see the message into screen. After eliminating the problem you can start the “Auto tuning” mode again.

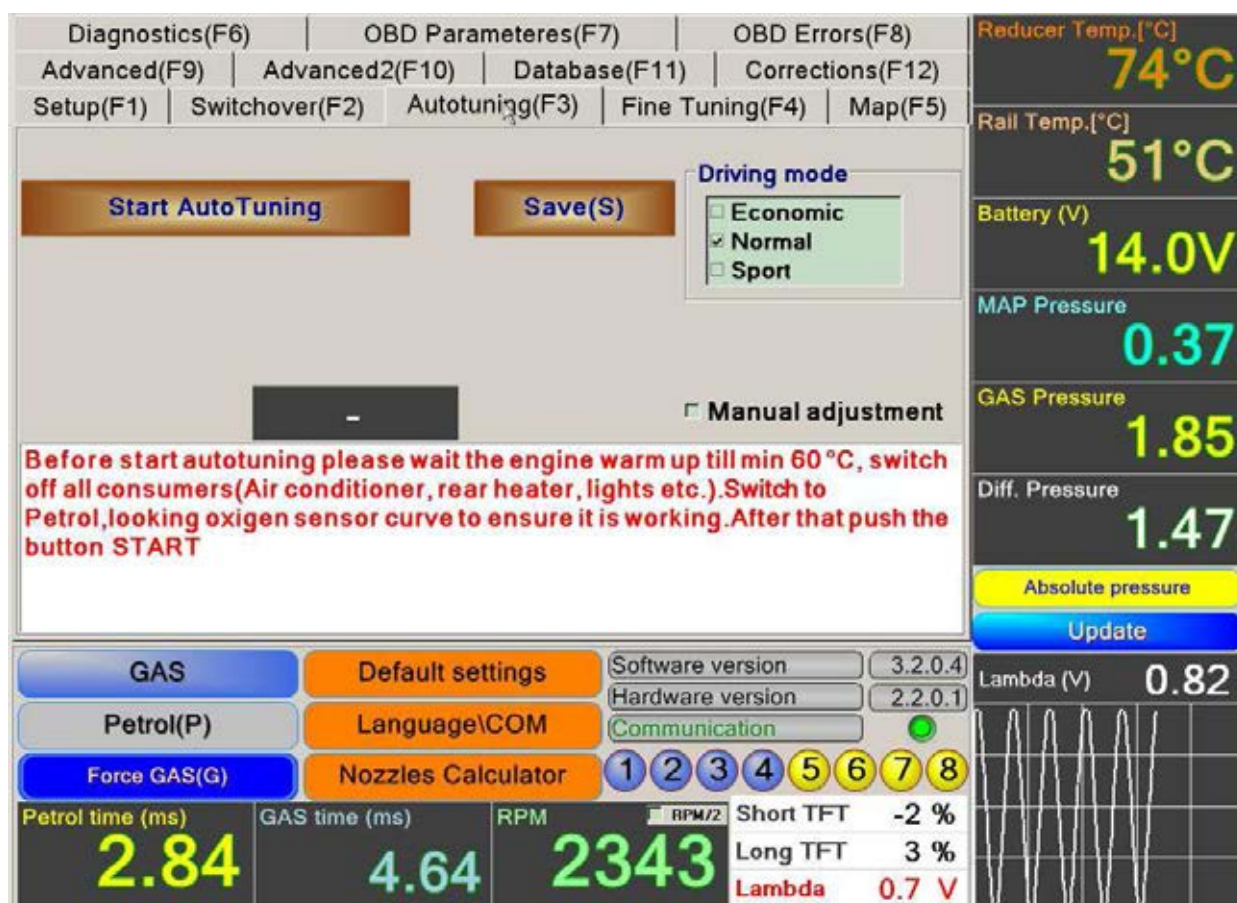

FIG.5

10. MANUAL ADJUSTMENT (F3)– FIG.6

Sometimes the automatic adjustment does not pass, so you have to adjust the coefficients manually. The steps are the following:

1. The engine runs on idle in petrol. In the upper square you see moment petrol injection time. When the petrol ECU starts vary lambda sensors you can switch on LPG.

2. In the bottom square is shown the petrol injection time when the engine runs on LPG. You have to reach both values almost equal – it could be done by slider - changing the current coefficient, push the “SAVE” button to record into the ECU. For more precise adjustment you can do it by using the coefficients in the menu “Fine tuning” /FIG.6/ when the car is moving on different road types, to ensure more loads for the engine and speeds. In the menu you have push button “calculate map”. This is the connection between the linear adjustment with coefficients and the 3-size map, which is table of coefficients, depending from petrol time and RPM. This button gives you possibility to switch from easy to more detailed adjustment. Driving the car with constant RPM and gas pedal (fixed TPS), you see the blue line on the petrol inj. time. You have to switch from petrol to LPG and move with arrows up or down current coefficient till the valve, when the petrol inj. time is equal on petrol and LPG running. The same procedure for different petrol times will give you more precise adjustment. By arrows of the neighbour coefficients you have to adjust them so, the red curve is slight falling down to the high /FIG.9/.

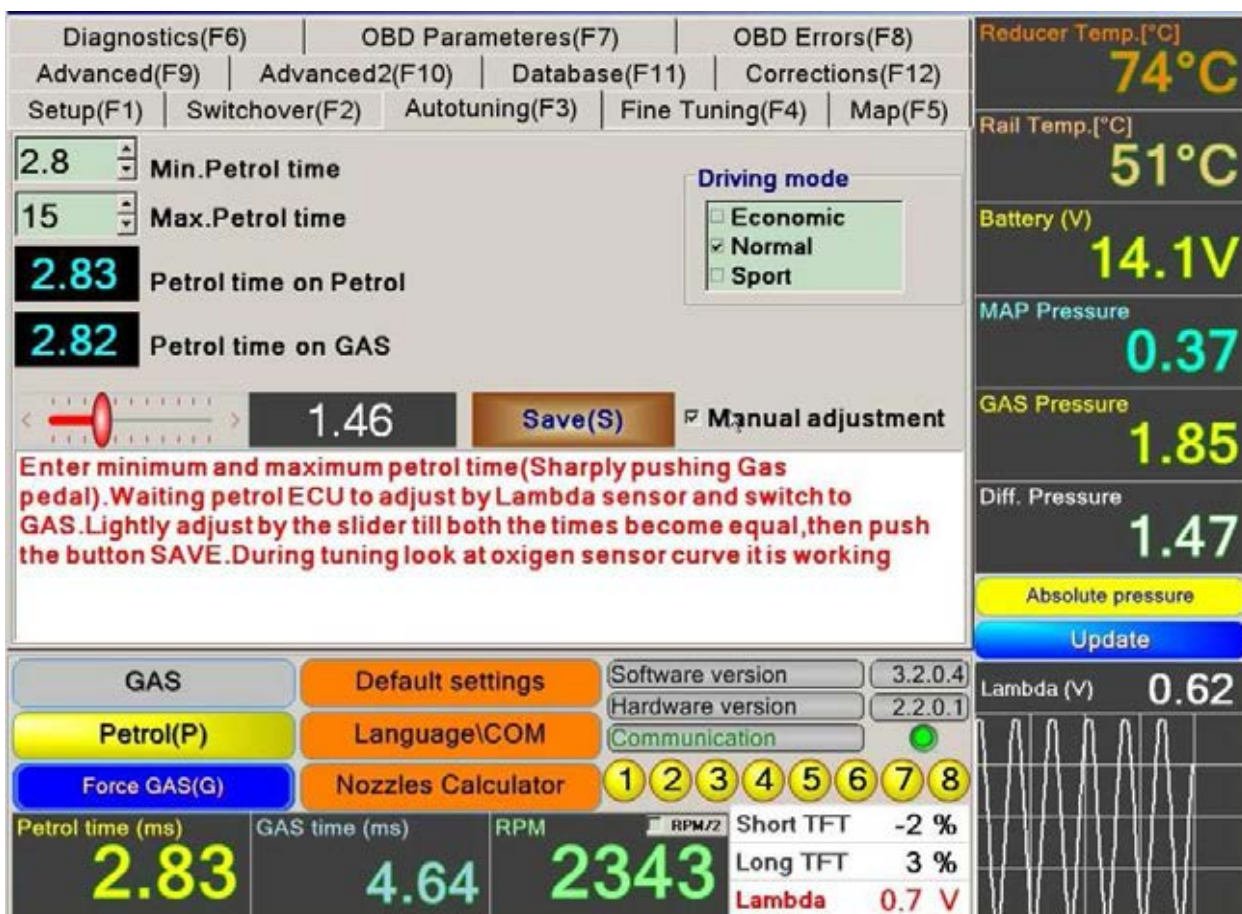

FIG.6

11. MENU "FINE TUNING" – (F4) – FIG.7

Until now all the operations are executed in "Petrol" mode. When the temperature is minimum 20°C you can switch over in "LPG" mode looking for the differential pressure to be near to 1.5bar. When you have normal RPM in idle, pressure, working engine with increased temperatures over 70°C on the reducer and at least 50°C on LPG rail, you can go to auto tuning mode. Anyway, from the menu "DIAGNOSTICS" (FIG.5) you can switch each cylinder separately on LPG, looking for normal engine behavior in this case you can catch eventually not working LPG injector or improper sequence which could be easy normalized by using the injector terminals.

The real sign for improper sequence of the cylinder arrangement you can find when switch-over LPG/Petrol or vice versa in case the petrol injector times in "Petrol" mode and in LPG mode are equal. You can adjust this equality by using the arrows near in the "FINE TUNING" (FIG.7) menu, waiting near 10 seconds and switching over a few times Petrol/LPG. If after this procedure the engine is still shaking for a second when switchover the fuels you must check the sequence of the LPG injectors. Rarely the mistake could be from the hoses row to intake manifold, it is easy to correct by rearranging the connectors on the LPG rail.

The main features here concern to the table with coefficients, now increased to 32 and the value of the petrol times, reached to 25 ms. Because of the increased range the coefficients (up to 25 ms) for the cars with standard features you could miss to adjust the bigger coefficients.

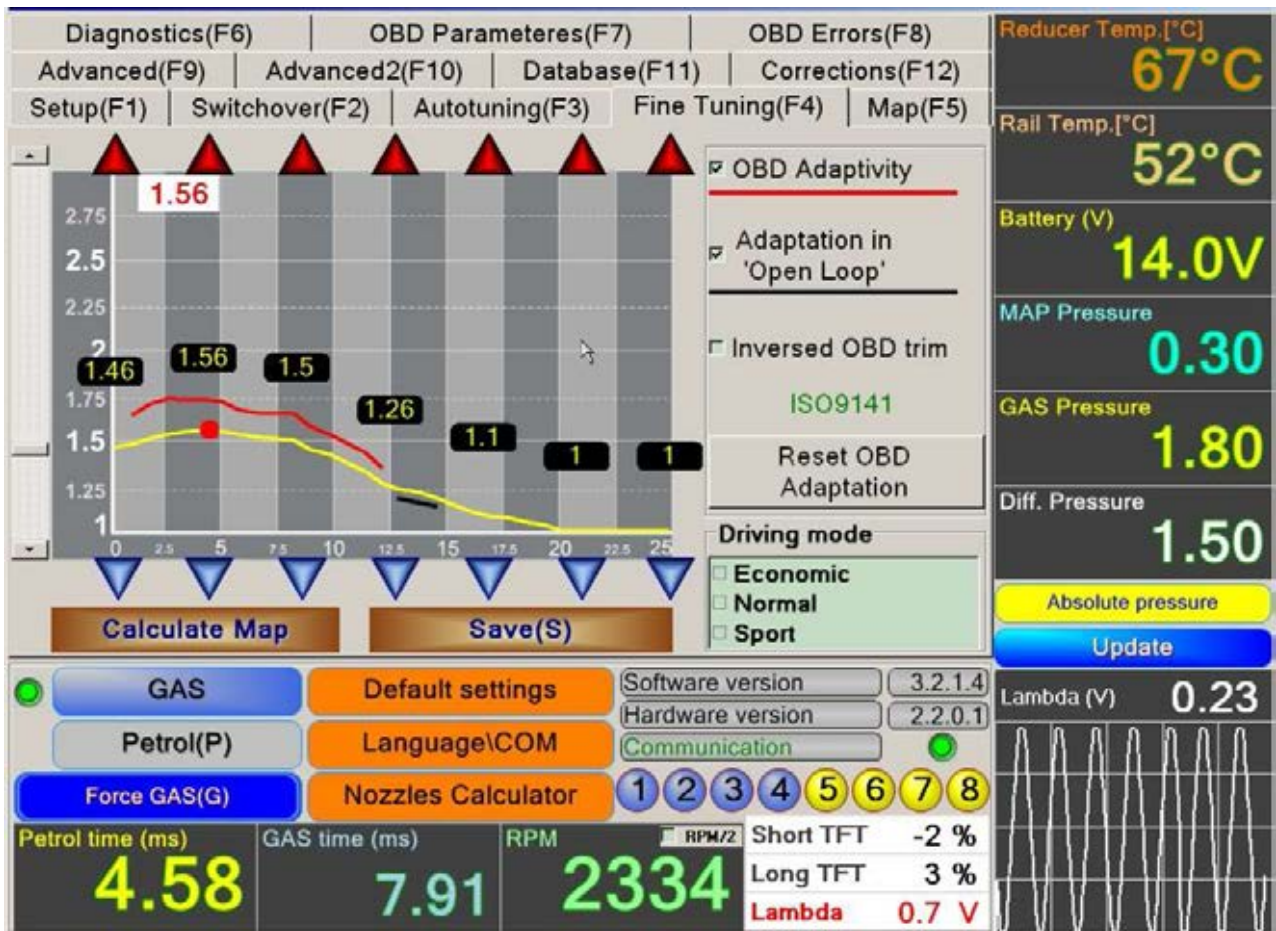

FIG.7

To facilitate users in menu "Fine Tuning" are added several functional buttons on the graph of coefficients - red and blue triangle buttons which allow adjustment in seven points of the diagram. By them in different areas (Low, medium and high) of the motor loads you can smoothly regulate rates.

From left to chart is added slider, which is carried out by moving the entire schedule all coefficients vertically. Activate slider by double click on the chart. (Fig.7)

You also have to make fine tuning when you notice the change in the way of working of the engine (loosing power or increasing the consumption of LPG fuel).

From the "FINE TUNING" (FIG.7) menu use the checkbox labeled "Normal". On the screen you see coefficients; the working in each moment is colored in RED point. Ensure permanent load, RPM and throttle position (gas pedal) switch-over from "Petrol" to "LPG" and if the petrol injector times are changing, correct the colored in blue coefficient simultaneously with switching over. If the petrol time when turn over from "Petrol" to "LPG" is increased you have to increase the coefficient and vice versa till you reach the equality of these petrol times. It is recommended to use this procedure for more load conditions of the engine (at least 6-10). If you didn't manage to cover all driving modes using the arrows adjust all uncalculated coefficients near to the calculated ones. Looking over the curve, you'll try to make this curve smoother.

12. SELFADAPTIVITY IN F4 MENU /FIG.7/ ONLY FOR OBD SYSTEM

When the installation of the wires, used for OBD/CAN connection to the back wires of the car's 16-pin diagnostic connector is correct, you will see on the right side of the screen FIG.7 next to the chart: **OBD adaptivity, 'Adaptivity in Open loop', Reset OBD adaptation**". If you do not see them it means them it means that the wires are not properly connected. On the screen 'Fine tuning' you could choose by signing the check box **OBD adaptivity**, which allows you to adjust the gas system permanently on gas during all the driving time. The only thing you have to do in this case is to install the nozzles with proper size. After this the ECU will use factory set coefficients, modifying them all the time in all driving modes, storing them into the memory. After switching off and switching on again you could see with yellow line factory set coefficients (or the curve after manual adjustment or auto tuning). With red line you'll see the curve of the coefficients which gas ECU use, to keep the Short term fuel trimmer(STFT) close to 0%. Then you could readjust the yellow curve max. closed to the red one. This way if on some reason OBD connection is interrupted, the system will run properly adjusted. On the screen is also seen check box '**Adaptivity in Open loop**', which allow you to see what have to be coefficients when the petrol ECU stop to read the O2 sensor and run using internal tables with petrol times vs. RPM and other parameters. It usually happens over 4000 RPM and TPS more than 50%. If this check box is switched on and you drive in that mode, when close the software and open it again, it could be seen black curve, which give you information how you could adjust coefficients at high load.

Sometime the fuel consumption could be high, so we give the possibility to switch off these functions. In some cars the short fuel trimmers are opposite, so obviously you have to sign the check box, otherwise the system will be totally unadjusted. If you need to start new adaptation, just push the button "**Reset OBD adaptation**", the red curve will be erased. Driving in different types, the system will generate again the curve of the needed coefficients, which could be seen after closing the software and opening it.

Note: If there are problems with coefficient adjustment you have to switch off the check box "Adaptation in open loop" (Fig.6)

13. Menu "DIAGNOSTICS" (F6) – FIG.8

Then open menu – "DIAGNOSTICS" in order to check to correct cut-off of petrol injectors, their sequence and proper temperatures. If there is a sequential type of control of the petrol injectors you'll see on the left side of the screen and on the bottom the real RPM, also you'll see sequential movement of the colored squares for each cylinder separately. When the control is parallel 2x2 /semi sequent/ or "full group" you'll see it clearly on screen – Petrol injectors sequence. In this case you have to switch the RPM to real values by using the checkbox **RPM/2** in RPM meter. If there is a missing coloured square for some cylinder you have to check the electrical connections for petrol injectors, if all the squares are missing – you have to turn over the input connectors to petrol ECU side.

When the engine is "full group" or "Semi sequential" you must click also on the check box "Full group". By that the LPG injectors will inject fuel 2 times less (over tact). In this case you have use bigger size calibrated nozzles than standard for the pressure and the engine power. (Fig.5)

There is also statistic information about the hours the car is run on petrol, on gas, also the cycles of gas injectors are run, the hours left to the profilactic and maintenance. Here you could see two different times - from the very beginning and from the last control. It is useful for the installers to control the warranty and the elapsed time for the filter's change.

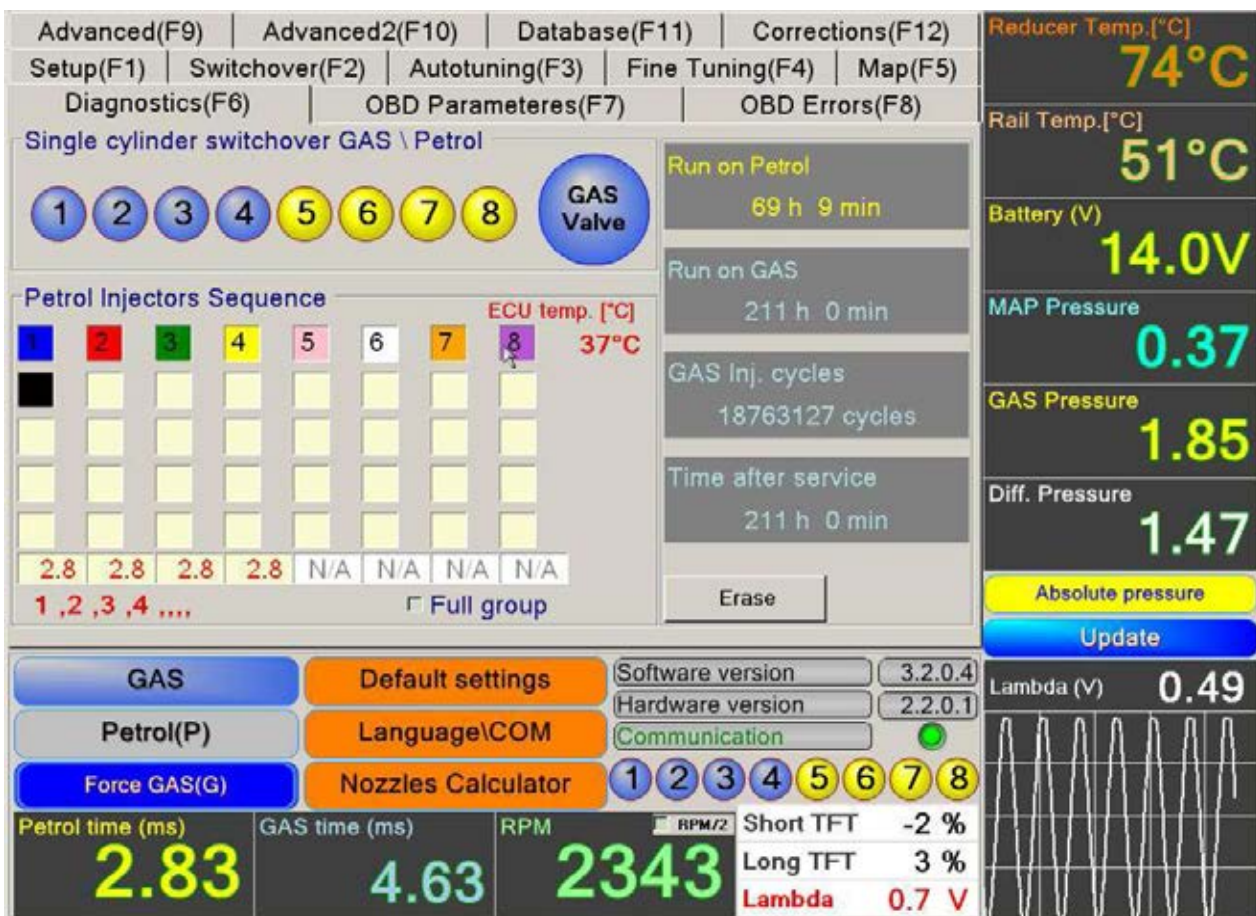

FIG.8

14. MENU “DATA BASE” (F11) – FIG.9

This screen is divided in two: “AUTO DATA” and “CUSTOMER DATA” “**AUTO DATA**” – if you want to create new folder with adjustment information for a car, after you fill lines “Automobile”, “Model”, “ENGINE TYPE” etc., by “SAVE AUTO DATA” button you could save the details for the given car, the software automatically creates the fails with the names of the car (Ford, Opel, Honda etc). The fails are with extension “*.LPG” or “*.CNG” depending on the first menu “SET UP”. So the created fails you can use to adjust the next car types from previous ones. By button “LOAD AUTO DATA” you choose corresponding fail, on the screen will appear button “LOAD in the ECU” and by pressing it you can load the adjustment parameters into the ECU.

“CUSTOMER’S DATA”:

After the adjustment of the system is made it is possible to save the information for about the customer. You have to fill the lines, by button “SAVE” you save information into a different file, useful for the installer. The names of the files with the data about the client are automatically generated like “CAR, BRAND, MODEL, PLATE NUMBER (for example OPEL_VECTRA_CA1234XB) which data you can change for your needs. The fails are with extension *.CNT and they are saved in subdirectory “CUSTOMER DATA”. On the time of maintenance of the LPG/CNG systems you can open the fails by button “CUSTOMER DATA” and to refer the adjustment for the car and the client’s data – like “kilometres”, “installing data” etc.

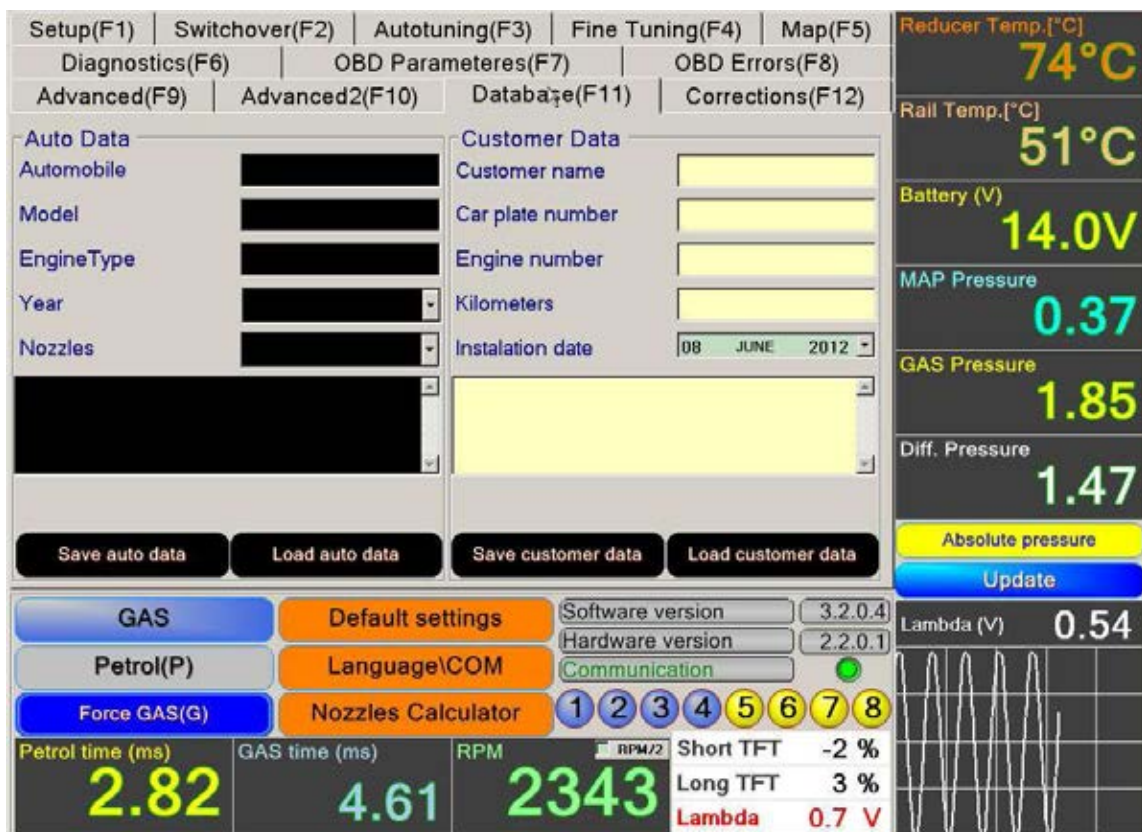

FIG.9

15. MAP (F5) – FIG.10

The system has an option to work with the three size “MAP” – it is the function of the coefficients depending from the revolutions and engine load – ms.

To work with the map, you have to switch to menu “MAP” and the check box “USE MAP”. There is also a red point, which is dynamic, signing the three parameters at the present moment. The change of the cell of the map or square of cells you can make by mouse marking (with blue colour) and pushing “ENTER”. You will see the small menu for type of modification of coefficients – linear, percentage and adding of value. These values in the map could be from 1.00 to 2.50. Each of the time when you change some cells, the system is working with these coefficients you have to save them by pushing “SAVE”.

The screenshot displays a software interface for MAP (F5) with the following components:

- Navigation Menu:** Diagnostics(F6), Advanced(F9), Setup(F1), Switchover(F2), Autotuning(F3), Fine Tuning(F4), Map(F5), OBD Parameters(F7), Database(F11), Corrections(F12), OBD Errors(F8).
- MAP Grid:** A table with columns for RPM (500, 1000, 1500, 2000, 2500, 3000, 3500, 4000, 4500, 5000, 5500, 6000) and rows for engine load (1.6 to 25.0). A red dot is visible at the intersection of 2500 RPM and 3.1 engine load.
- Map Modify Dialog:** A pop-up window with a 'Range' field set to -100 - 100, a 'Mode' section with 'linearity' selected, and 'OK' and 'Cancel' buttons.
- System Status Panel (Right):**
 - Reducer Temp.[°C]: 74°C
 - Rail Temp.[°C]: 51°C
 - Battery (V): 14.0V
 - MAP Pressure: 0.37
 - GAS Pressure: 1.85
 - Diff. Pressure: 1.47
 - Absolute pressure: Update
 - Lambda (V): 0.33
- Bottom Panel:**
 - Buttons: GAS, Petrol(P), Force GAS(G), Default settings, Language(C), Nozzles Calculator.
 - Buttons: 1, 2, 3, 4, 5, 6, 7, 8.
 - Readouts: Petrol time (ms) 2.84, GAS time (ms) 4.64, RPM 2343, Short TFT -2%, Long TFT 3%, Lambda 0.7 V.

FIG.10

16. MENU "ADVANCED SETTINGS" (F9) - FIG.11, FIG.12 and FIG.12.1

In this menu you can set up the following features:

- Slider for adjustment of **minimum gas time** for engines with not stable RPM at idle mode. For the most popular injectors VALTEK and RAIL or similar this time is 3.8ms +/- 0.2ms. Warning: For some cars with more capricious petrol ECU, using this slider may cause "Chenk engine" lamp, so be carefull using it, or better do not use it.
- **The slider 'Maximum gas time'** - is designed to adjust the times on gas, after them the system will open the injectors permanently, insuring enough fuel at high RPM and big power. This could be required for high power cars, over 200 PS or some turbo cars.

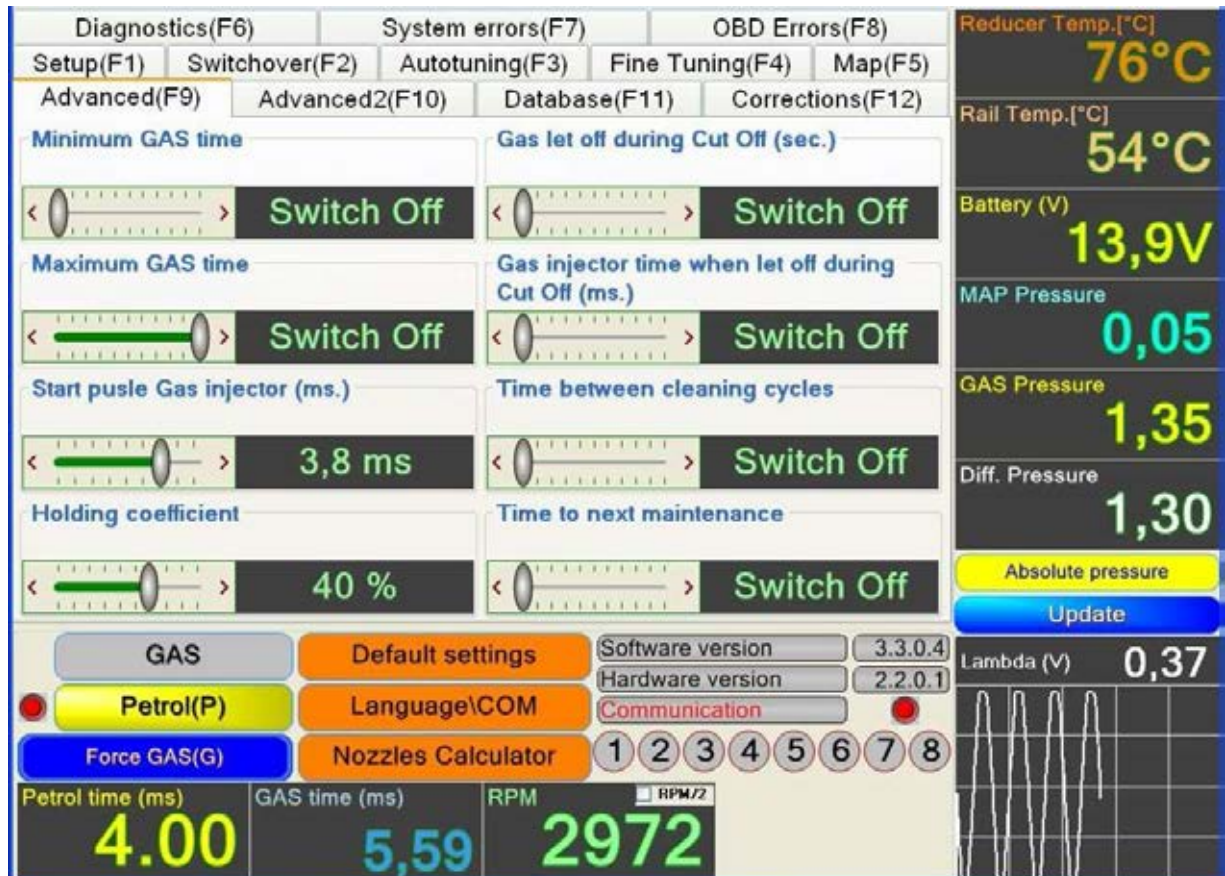

FIG.11

- **" Gas injector start pulse length"** for the injectors with different coil resistance (1, 1.5, 2, 3ohm) the lenght of the start impulse must be precisely adjusted, so by this slider you could readjust the necessary time for correspond coil resistance (basically in the system are given 3 ohm coils and factory set time is 3.78ms., you don't need to use this function). For some cars with very short petrol injector times (up to 2.2ms) the coils could be changed with 1.5 or 2ohm coils) in this case the system performance could be better. The times to be choosen are as follow: 1ohm - 2.5ms; 1.5 - 2.8ms; 2ohm - 3.2ms.
- **HOLDING coefficient** - specific setting for non standard injectors (10 Ohm without PWM). Use factory settings 40% +/- 2%. It is factory set, so please don't use it.
- **GAS LET OFF DURING "CUT OFF" – (only with double MAP sensor)** Slider decrease gas pressure after continuous "CUT OFF" mode for the engine, or for the "turbo" engines, which consume a lot of gas, also for the cars with big power (over 150 PS) with automatic transmissions, which are put often in "kick down" mode. First slider determines how much

seconds you have to let the gas off. (Sometimes if you choose the times over 5 sec., the petrol ECU could light the “Check engine” lamp, so this function must be used very carefully.

- **GAS INJECTOR TIME WHEN LET OFF DURING “CUT OFF” (only with double MAP sensor)** Second slider is used to adjust the length of the let off cycle.
- **Time between cleaning cycles** (from 1 min to 4 hours) – the function allows cleaning of the petrol injectors automatically for 1 min on period set from the slider. This is useful for company cars, taxi cars and courier cars with high mileage.
- It is established also the feature, which allows clean the petrol injectors automatically on the time the machine is running on gas. This is very useful for the cars with very big mileage, such as taxi cars or fast courier cars. There is slider, which adjust the period between one minute petrol cleaning.
- **Temperature for direct ignition on gas** – switched off in right position.

Sliders in „Advanced setting 2” (F10) – FIG.12

- **Switchover RPM from gas to petrol:** The system allows turn over from GAS to petrol in range of RPM (2000-8000 RPM). For example if the car goes over the set 5000RPM the system automatically switches to petrol. The function is switched off if slider is in right end position.
- **Switchover RPM from gas to petrol at idle:** if running on gas car goes under the chosen RPM, the ECU switches to petrol. The function is switched off when slider is in right end position.
- **LED Indication:** If the installer needs to hide the LED indication when switching from gas to petrol, just sign the check box under the corresponding slider.

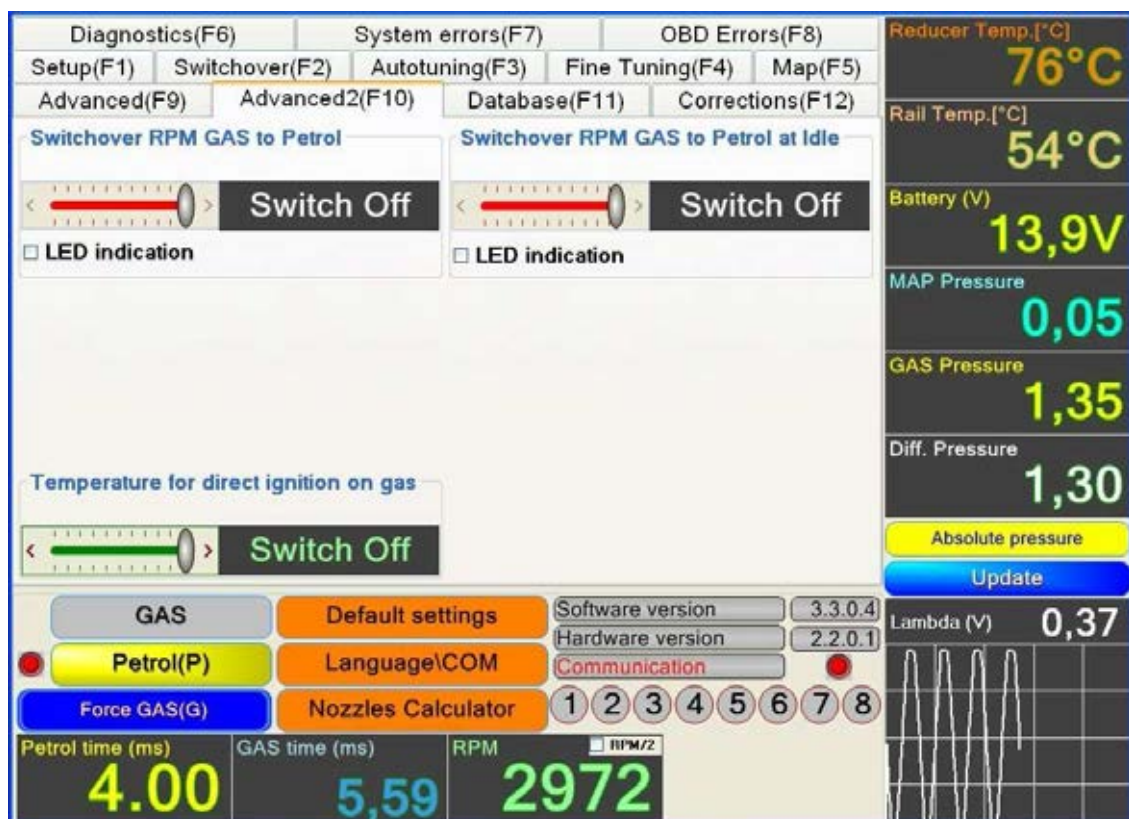

FIG.12

- „Advanced setting 2” (F10) – FIG.12 .1 –
/IF USING THE SYSTEM WITH PARALLEL PETROL INJECTION/

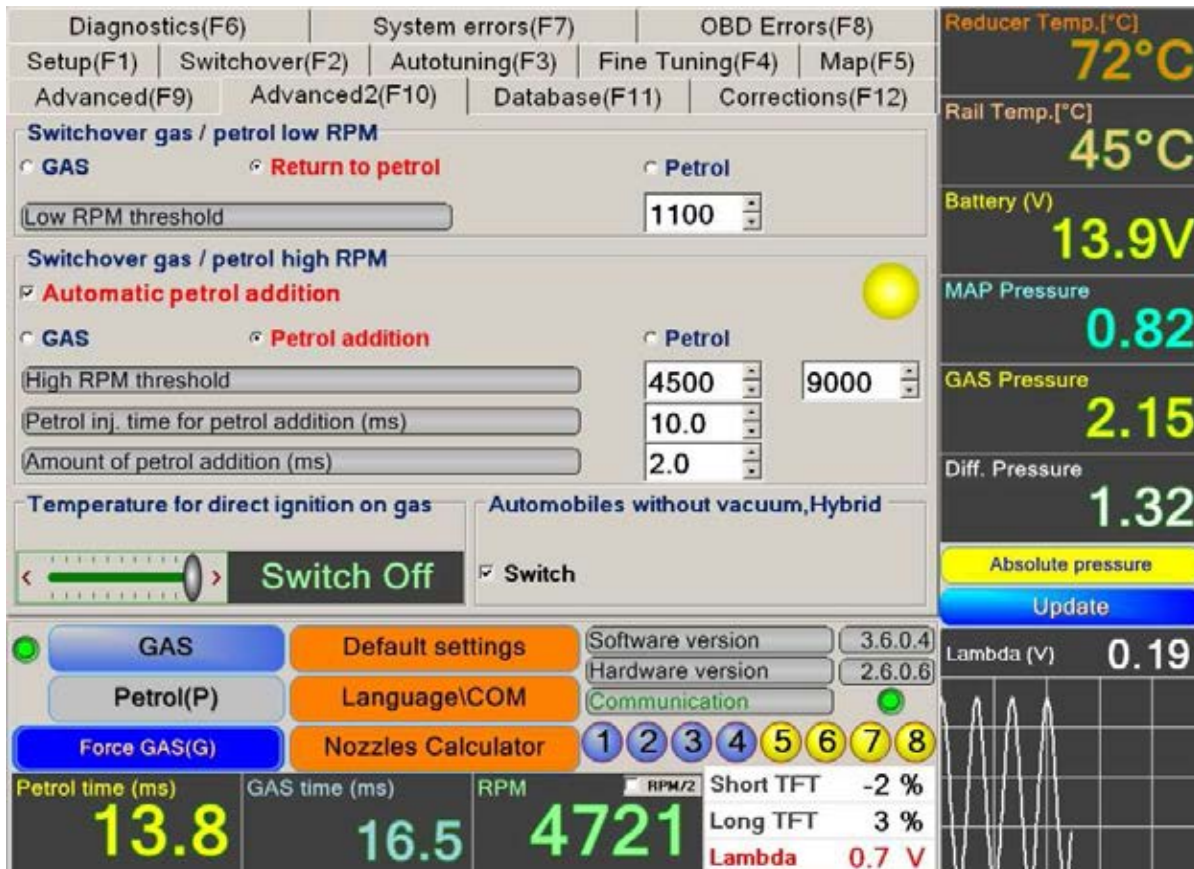

FIG.12.1

In this menu you can set the conditions under which the system operates (switches) to gas or petrol or injects additionally petrol.

- Switch from gas / petrol at low RPM:

Gas - Vehicle constantly working on gas.

Low RPM threshold - shows RPM under which the function is activated.

Petrol switchover - system switches to petrol for a few seconds then goes back to gas.

This function is recommended for vehicles where RPM fall dramatically then the system switches to petrol to stabilize RPM for a few seconds and then again switches to gas.

Petrol - Under set rpm the car runs only on petrol. If RPM become higher than the specified car goes back to the gas. Function is recommended for vehicles that operate at idle unstable gas.

- Switch from gas / petrol at high RPM:

Automatic petrol addition at a gas shortage - when the function is active the system automatically adds the required amount of fuel for heavy loads (ms) and high RPM.

Gas - Vehicle constantly working on gas.

Petrol addition - Upon reaching the specified range of RPM / example 4500 to 9000 RPM / and upon specified petrol times / example 10ms / the system adds the specified time petrol / example 2ms /.

Petrol - Upon reaching the specified range of revs / example from 4500 to 9000 RPM / and upon specified petrol times / as 10ms / system runs entirely on gasoline.

The software is indicated by adding or switching to petrol with a yellow dot.

- Vehicles without vacuum, hybrids – check box “Switch” have to be turned on for the cars that are without vacuum (Valvetronic) or hybrid vehicles with start stop system operation.

17. Menu "Corrections" FIG.13

The software gives possibility to adjust the temperature or pressure corrections or to switch them off if needed. In the middle of the upper part of the screen is the bar, you have to fill the working pressure of the reducer or the pressure you've adjusted according to the needs. In the both ends of the table you see two sliders, by them correction could be increased or decreased (in %). The second table work the same way, just there are two additional sliders, which add correction at idle in ms, after that it is decreased automatically by the software.

Note: When make deeper correction, basically for the pressure, keep in mind, The gas times could be very big at high rpm and power, the max. time has to be up to 26 ms at 6000 rpm.

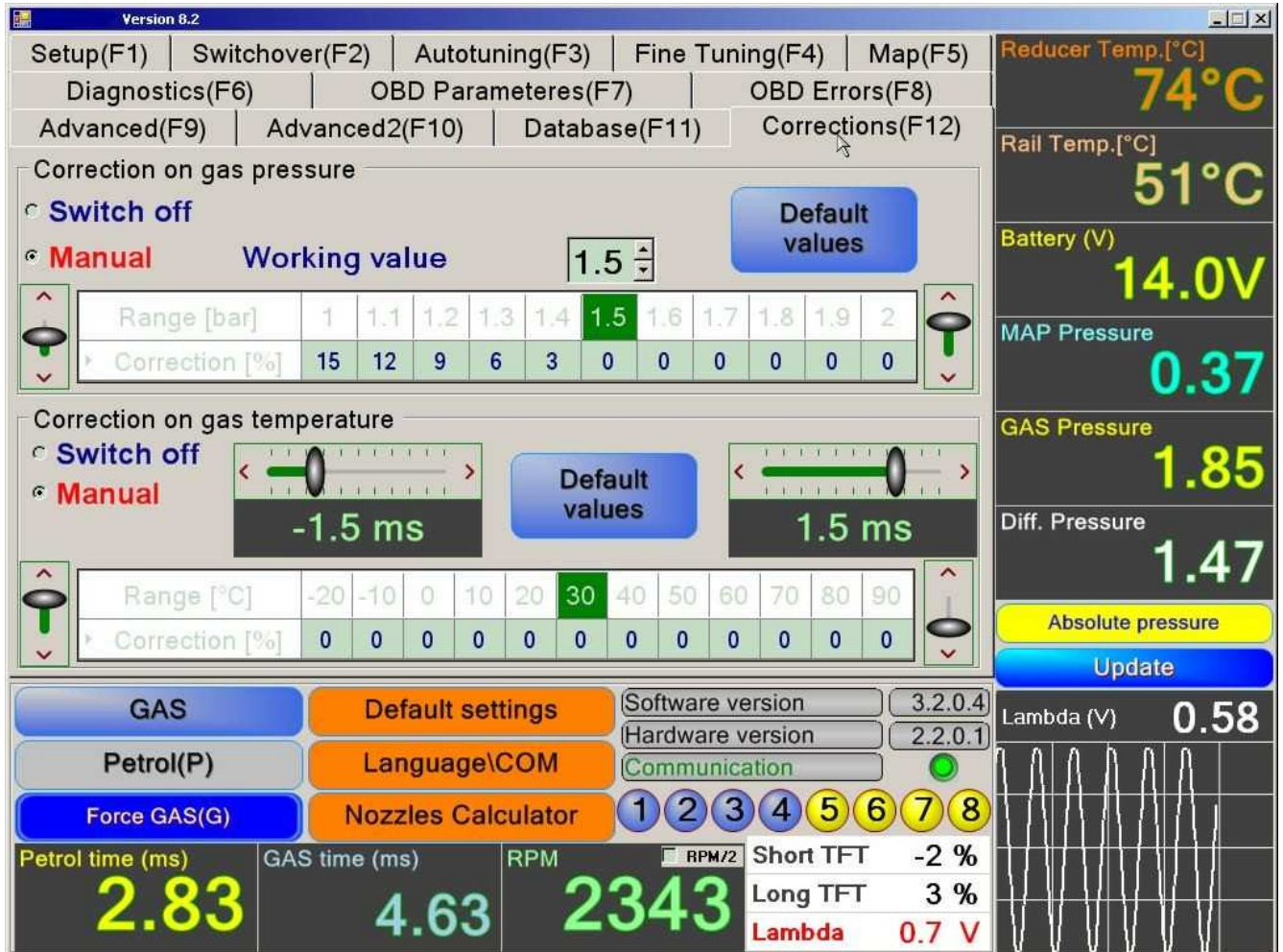

FIG. 13

18. OBD/ CAN communication modul – only for OBD system

This chapter will give more information about the OBD/ CAN communication modul and will direct to easy adjustment of the system. First of all you could see two screens in the menu “System Errors” (FIG.7) and “OBD Errors” (FIG.14) . The most important parameters from OBD are: “short” and “long term fuel trimmers”. For convenience you will see these parameters also on the proper place in all teh menus. Shortly you have to know, that you need to keep them near to 0%. If their values are very different from 0% at petrol, you need to readjust the coefficients in gas mode so, that the values of these both parameters have to be equal to them in petrol mode (for instance at petrol mode they are +18%, adjust the coefficients this way, they are near +18% in gas mode). Here is the place to mention what these two parameters mean. If they are permanently positive (+.%), it means the fuel mixture is too lean and the petrol ECU will try to encrease the injection times to compesate this. If their values most the time are negative, the mixture is rich. Most often these parameters are positive when the petrol injectors are dirty or negatjve when the car is run over 100 000 km or the air filter is dirty. Analizing these parameters you could find some problems in the gas system in whole. For instance after 30-60 thousand km meleage the gas injectors increase the flow rate, so the gas ECU make the fuel mixture rich and the “short and long fuel trimmer” became negative. In this case you have to readjust the coefficients properly.

The other mode in the menu is “OBD Errors” /FIG.14/. Using this menu, you could read, analize and clear all errors, established on the time of installing, adjusting and using the gas system any time.

NOTE: Here is important to inform you, that you have to clear the errors after carefull analisys. In some countries there are restrictions to do this. So you must to be very careful with this feature! It is very useful to make easy diagnostic, using our system software when you make maintenance control for the gas system at all.

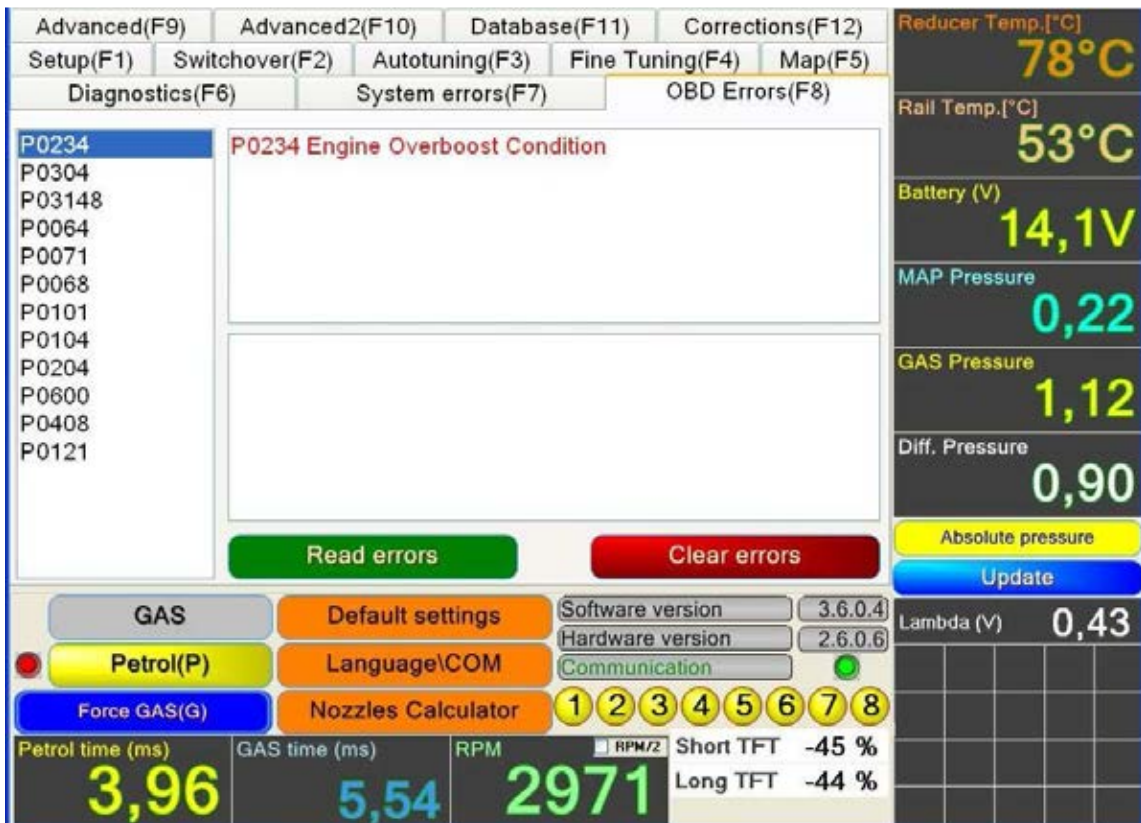

FIG.14

19. Menu "GAS system errors" - (F7) FIG.15

After the system is fully adjusted, all the parameters could be tested in drive mode, after that you can receive from this menu some useful messages for unprecised adjustments or wrong choises of nozzles, pressures, times etc. parameters.

The messages lead you what could be done better, but they are not 100% required.

The error messages are as follow:

- "Lean mixture in maximum gas time",
- "Rich mixture in multiplier 1",
- "Rich mixture in minimum gas time",
- "Low voltage",
- "Low voltage on gas"
- "Rail temperature sensor Circuit Open",
- "Reducer temperature sensor Circuit Open",
- "MAP sensor Circuit Malfunction",
- "High gas pressure in 'Cut Off'",
- "Low gas pressure",
- "High gas pressure on gas",
- "Low reducer temperature",

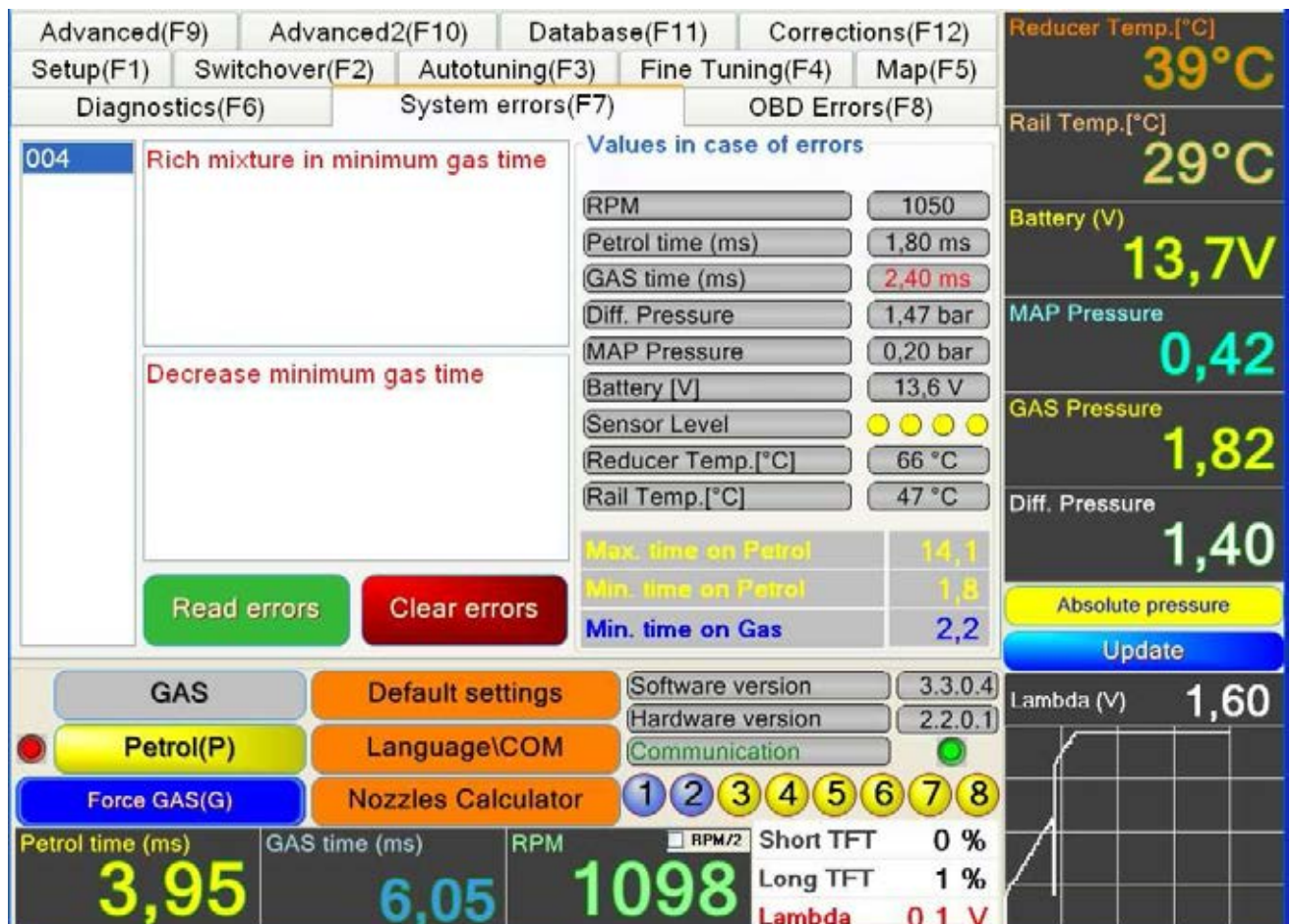

FIG.15

20. SOME USEFUL HINTS

These notes will give you information about the possibility to adjust the system, installed on the cars with some special features, like “full group”, short injection times etc.

First we need to explain the thresholds, where the system working properly. For the coefficients they are between 1.0 and 2.5. It means, that all the petrol injection times will be multiplied with these values. For instance if the current coefficients is 1.8 and the petrol time at idle is 1.9ms, the gas injection time will be 3.42ms. Here is the place to inform, that the injectors work properly with times between 4.0 and 24ms. So you could see from upper exercise how the system could be adjusted out of range of proper work. All the good adjustment is related to proper combination between nozzle's size, multiply coefficients, reducer pressure and map adjustment. Every time the long hoses (over 25 cm.) and the remote drilling into manifold (more than 3cm.) away from petrol injectors are not permitted due to avoid unstable work at idle. Let us to see one exercise – for instance BMW 2.5i car old model – full group, 1994, 6 cyl., 192 PS., automatic transmission. According to table for the nozzle sizes, we could choose 2 mm nozzle. Because this car is “full group” car, by check box on the diagnostic screen we switch to this mode. In this case we increase the nozzle size to 2.5 mm and start the auto-tuning mode. If the self-adjusting is OK, the owner could test the car on the road in all regimes – middle speed, big speed with low rpm, kick-down mode of the transmission, etc. Often in the high rpm mode (over 4500 rpm) the engine need more fuel, so you could increase the coefficients near the place of the blue band – current injection time. Every time we have to be careful with the value of the gas times (green) – not more 22- 24 ms at 5000 rpm. Sometimes for better performance we could switch over 5000-5500 rpm by slider engine to work on petrol. If the auto-tuning mode doesn't pass OK, we could adjust the system manually, switching the check box “manual adjustment”. In this case follow the manual recommendations. For many reasons the software could give the message in the note screen (red color) which is not correct (big nozzles, etc.), we adjust the coefficients according to good work of the engine.

Sometimes, for the cars with bigger power and especially with automatic transmission (40-60 PS/cylinder), we need to increase the coefficients for middle and high loads (over 8-10 ms) with 10-40 % at least, so in this way the coefficients curve on the “Fine tuning” screen become with smaller slope and even horizontal flat. It is make by automatic calibration (self tuning) and later manually.

For the “full group” cars with small petrol injector times (less than 2.2ms) you have to be careful how to choose the calibrating nozzles, to ensure coefficients at idle at least 1.9 – 2.1. Because in “full group” mode we inject the gas two times less than petrol, the nozzles must be at least two sizes bigger, than in normal mode (the check box “full group” on the diagnostic screen must be switched on). In these cars could be seen other problem – at high speed, big rpm (over 4500) and TPS over 50-60% the bad, interrupting performance of the engine is seen. It is because of the totally open gas injectors at this regime. It could be avoid by decreasing of multiply coefficients (the gas times must be under 22-24 ms at 5500-6000rpm). It is going against the requirement for the big coefficients at idle, so we need to find the right “middle”. In these cases sometimes is more difficult to stabilize the rpm at idle. Very rarely we have to do this by using more fast injectors (with opening time not more, than 2.5ms – the standard ones are around 3.5-4 ms.) If it is not possible, the MAP adjustment could be useful. We have to adjust the system by auto-tuning procedure, after that by buttons “Calculate MAP” and “Use MAP” we open the MAP screen, where it is seen the red point, moving into 4-6 fields. Marking them, changing the values up or down between 10-20% we

could stabilize the rpm at idle. Very often the length of the pipes to manifold have to be shortened less, than 20 cm. to stabilize the idle rpm.

21. SOME DETAILS ABOUT PROBLEM CARS

Here will be given common information about some cars and their models with non standard features; it could be problematic on the time of the adjustment of the gas system.

These details could be: very short petrol times at idle, semi-sequent with regular rpm, existing very short petrol times in 'cut off' mode, switching in the middle TPS from one to two injections per cycle, small petrol times at idle and big times at high rpm, switching after a time from 'full group' to 'sequent' mode, easy switching after "misfire" to 'safe' mode, lighting the 'check engine' lamp, opened petrol injectors permanently at high rpm etc.

- **Old cars Citroen, Fiat, Peugeot 1992-1998**

They are 'full group cars', injecting twice in cycle with very short times, the manifold is separated 1-2 and 3-4, which make shaking unstable idle, problematic high RPM.

- **Daewoo, Schevrolet, VW Golf, Polo/93-96**

These cars switch the injection from 'full group' to full 'sequent' after a time or over some RPM. They could be adjusted, using map or with low pressure and flat curve of the coefficients. Of course the best way is to use fast injectors with any pressure.

- **Mazda 2000-2010.**

Their ECU switches in the middle of the RPM from sequent to sequent twice faster per cycle. The solution is fast injector or flat horizontal curve of the coefficients.

- **BMW, Mercedes.**

Very often these types inject with short times (1.7-2ms), which is problematic with standard slow injectors(min.3.5ms). With big coefficients the problem goes to high RPM, because usually these cars are powerful, over 140PS, so better is to use fast injectors, 'full group' function if the cars are older. Sometimes with 1.5 ohm coils could be reached sufficient results, but keep in mind the life of the injectors become shorter. For BMW 2.0, 6 cyl., 150PS, 2000year or close by nozzles 1.6-1.8 mm could be reached also good result.

- **Subaru.**

This car has no 'cut off' mode, the ECU inject with very short times (0.6-2ms). It works well with standard or fast injectors. They are 'boxer' engines, so it is required to use 2 two cylinder rails or 4 single injectors.

- **Cars after 2001 over 180 PS.**

Usually they are with small idle times (1.8-2.5ms), but enough big times at high RPM (20-25 ms). If you adjust the system with big nozzles to ensure enough fuel at high load, the idle could be shaking. The best solution is to use fast injectors or if is allowed from the petrol ECU (the 'check engine' could be light), you could use 'Minimum gas time' from the menu 'Advanced' of the software, moved the slider to 3.5-3.8 ms.

- **Lancia 94-98**

This car at high load opens the petrol injectors permanently, so you need to use the function from the gas software, so called 'Possibility of permanently opened injectors'.

- **BMW series 3, 1998-2008 without vacuum (Valvetronic)**

It could be adjusted by fast injectors with different adjusting curve. It is flat, adjusted at idle, after it is raised to the end. For instance coefficient at idle is 1.4, at the end coefficient is 1.8. From the software you have ready curve, loading with the button.

- **Turbo cars.**

In this case you need bigger pressure, at least 1.6-2 bars, also be ready for big times at high RPM. The reducer need to keep small drop out of the pressure at high load. Here you could use the function 'Minimum gas time' and small coefficient with big nozzles, of course calculating them by the nozzle calculator, choosing one or two sizes bigger ones.

- **Mercedes 1993-1998, compressor all years, etc.**

This make is very precise with the fuel dosage and switches off every cylinder separately if we are not supplying enough fuel. That is why you need to adjust precisely the fuel, if the car is after 2001, better use OBD system, adjusting fuel, at different loads and RPM, looking 'Short term fuel trimmer' from the OBD.

- **Mercedes compressor – 1998-2011.**

These cars need a lot of fuel in high RPM, sometime even the multivalve could not ensure enough fuel, so better use extra size. Also the reducers have big drop out of pressure, which have to be compensated by increasing of coefficient at high petrol times. Tomasetto reducers are not suitable for these cars or at least Artic have to be used. Our Gama 01HP -300PS is much better. Zavoli Zeta S or up to 240PS Zeta N is suitable. If you use separate valve, use better big flow valve. If the petrol times at idle are less, than 2.5 ms, please use fast injectors (Horizon, NIGS- FIR-1/3 or other) with opening times less, than 3ms. The Turkish injectors are not suitable in this case. If the cars are after 2001, please use OBD system for precise adjusting of the fuel mixture to avoid switching off of cylinders and lighting of check lamp. The auto calibration have to be modified, increasing the coefficients in driving, looking OBD short term fuel trimmer to be less, than +/- 20-25%.

These cars could be adjusted easy if you use fast injectors, but with the well known Rail/Valtek it is complicated. The most important is to use reducer with lower pressure (0.8 to 1.1 max). Helpful is also to use 2 or 1.5 ohm injectors. In our software is one function, which solves most of these problems - check box 'full group'.

These cars work in the beginning 'full group', after a time or some RPM they run 'sequent', which requires fast injectors. If you try to adjust these cars with standard injectors, try to put the curve of the multiply coefficients horizontal.

These cars running 'sequent' normally for TPS up to 50%, after their ECU inject sequentially twice in cycle, which requires or fast injectors, or at least horizontal curve of multiply coefficient.

The "Subary" doesn't have real "cut off" mode, in this time you could see very short injection times - between 0.6 and 2 ms. If you find some shaking, please use fast injectors or use the standard with bigger coefficient (1.8-2.2). In this case be careful with high RPM, the engines are powerful and need more fuel. Check the maximum petrol times and find the balance between nozzle size, pressure and the coefficients basically at high RPM.

'Direct injection' cars. Here will be mentioned some makes and models, which could not be converted on LPG or CNG.

"Mitsubishi' GDI; Opel Direct, M Benz direct, Citroen Direct; VW, Skoda, Seat Audi FSI, TFSI; Alfa Romeo JTS and other with direct injection.

Other cars with the catalitic system problems - Nissan Xtrail and Nissan Qashquai.

Other old models, with "Renix" petrol ECU - Renault Espace, Safrane, Jaguar - years 1992 to 1998. They could be checked easy, measuring the resistance of one of the petrol injectors. It has to be bigger, than 3 ohm, at least 10-18 ohm.